

Achenbach metal hoods



With the cooperation of Achenbach Metalltechnik GmbH and Hamco Dinslaken Bausysteme GmbH another important step regarding expansion of our sales programme has been completed.

Because of the longtime experiences of the two companies in their activity areas and the perfect matching products a promising and successful partnership can be expected.

Measures for Achenbach metal standard hoods

Different surfaces

- galvanized on both sides
- alu-zinc
- coated with RAL colors

Different materials

- quality steel (galv.)
- aluminium
- stainless steel
- special synthetic (on demand)

Hood No.	Width of band a [mm]	Width of framework b [mm]	Radius r [mm]
0	300	600	300
1	400	700	350
2	500	800	400
3	650	950	475
4	800	1150	575
5	1000	1350	675
6	1200	1600	800
7	1400	1800	900
8	1600	2050	1025
9	1800	2250	1125
10	2000	2500	1250
Special measures and shapes on demand.			



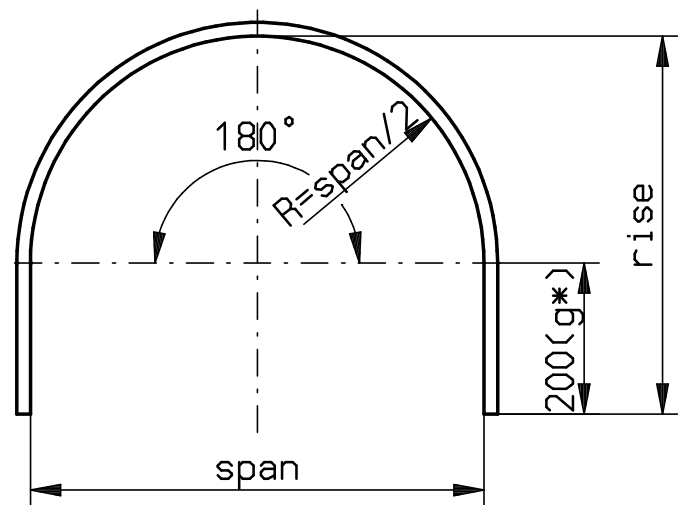

* dimension "g"
standard length: 200 mm
min. length : 150 mm
max. length : on request
also available without straight haunch

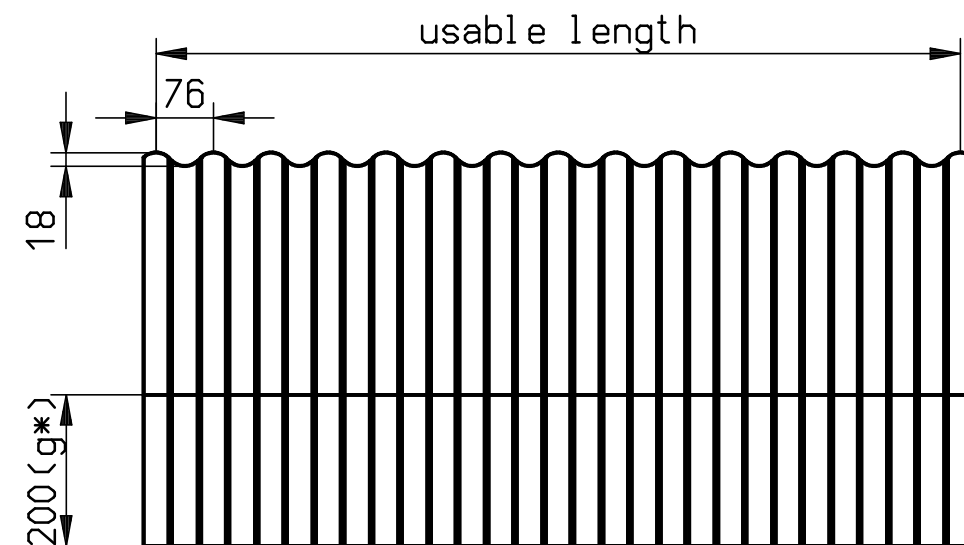
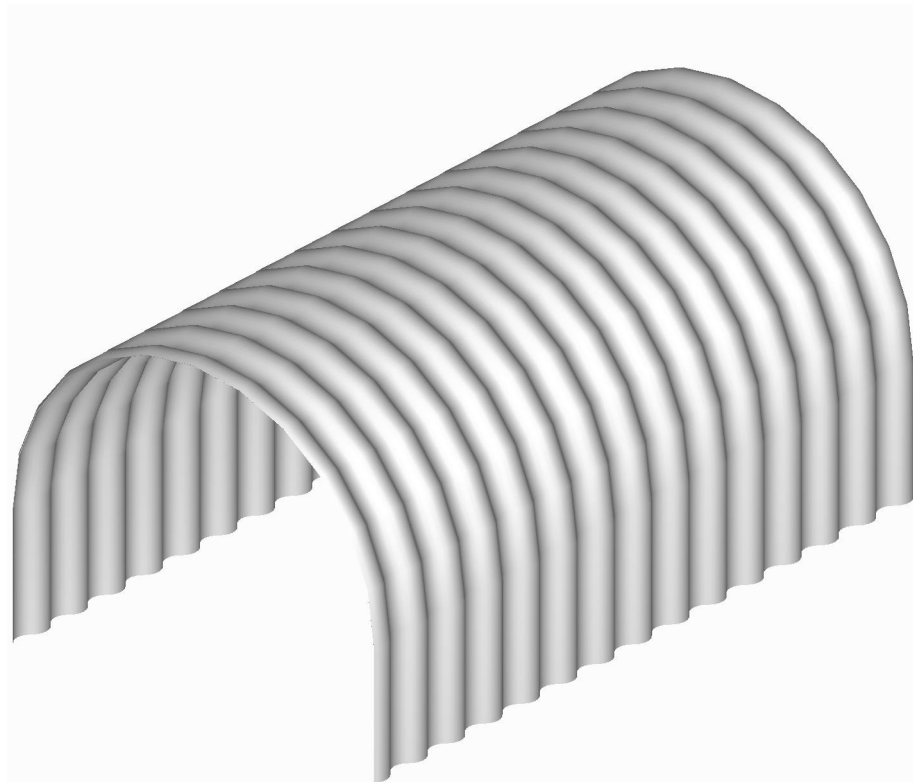

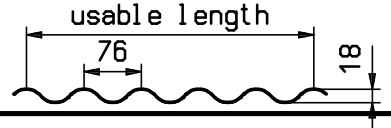
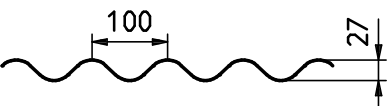
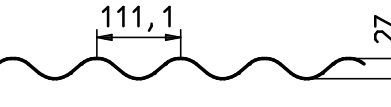
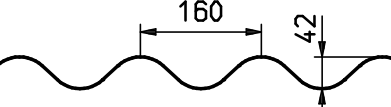
corrugation 18/76 : 	usable length
	836 or 1064
also available:	
corrugation 27/100 : 	usable length
	800
corrugation 27/111 : 	usable length
	1000
corrugation 42/160 : 	usable length
	960

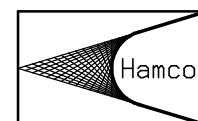

Hamco Dinslaken Bausysteme GmbH
Otto-Lilienthal-Straße 17A - 46539 Dinslaken

Construction item	Scale	1:10
standard cover sheet HA	Date	19.05.11
	Drawn by	Wolf
	Approved by	Lindenau
	Order no. :	-

[mm]